

Data Sheet



Article number: 20128280AL

Description: E+G Hinge for weld mounting GN 128.2-80-AL
Aluminium hinge/pin stainless 1.4301

Measures

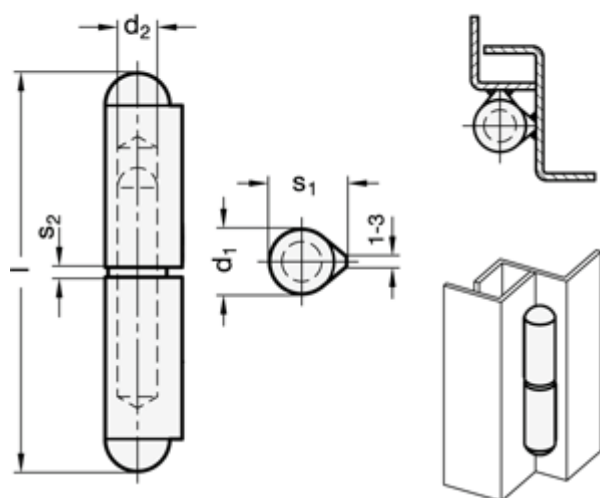

d1	= 13
d2	= 8
Length l	= 80
s1	= 15.5
s2	= 2